

BROWNIE ONE SERIES (AM)



BROWNIE ONE (AM)

BROWNIE ONE is a versatile, elegant and slim office luminaire. It is available in two widths and three different mounting options, recessed, surface-mounted, and suspended. Up to four different lengths are available to form a continuous row of lights, as well as a system or as individual luminaires.

The series is designed as a lighting solution for upscale offices and commercial interiors.

They ensure uniform illumination and provide pleasing ceiling lighting, creating a friendly working environment.

Shape

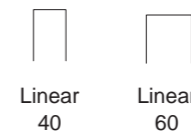

Linear
40

Linear
60

Mountings

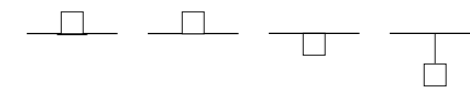

Recessed
Trim

Recessed
Trimless

Surface
Mounted

Pendant

Light distributions



Downlight



Specification

2700 K, 3000 K, 4000 K,
CRI ≥ 90

Types

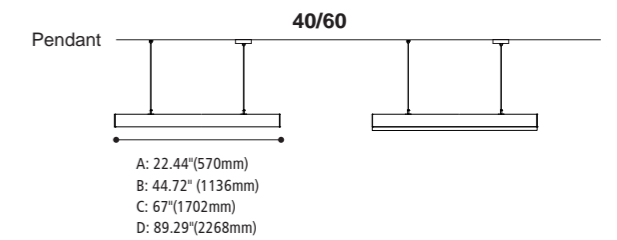
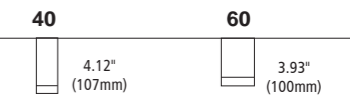
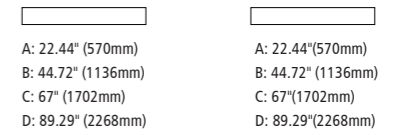
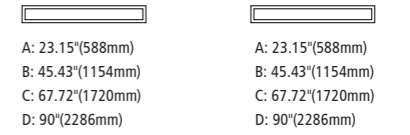

Colours

Bezel : ● ○
Black White



BROWNIE ONE **40/60** (AM)

Recessed

Trim/Trimless

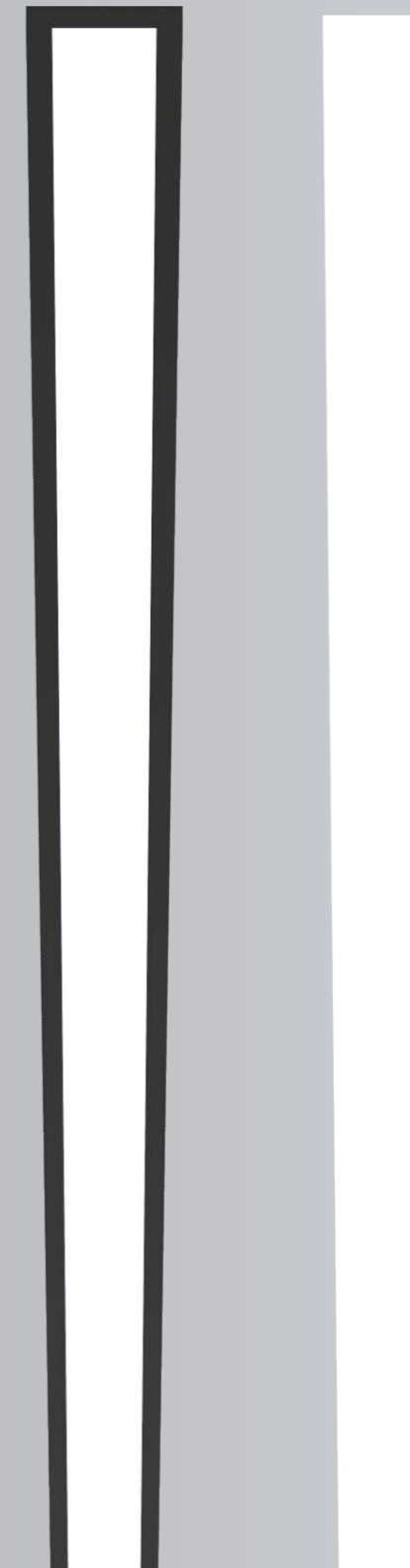

BROWNIE ONE 40 -TFP

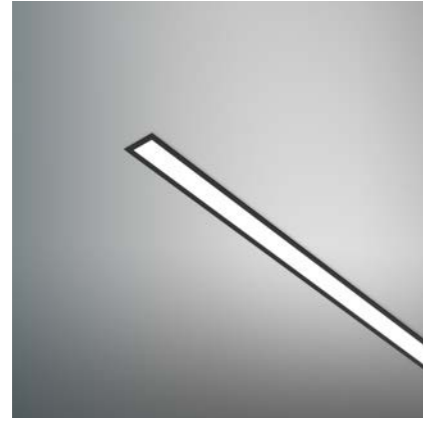

Article number	2114.416A-V-AM 2114.416B-V-AM 2114.416C-V-AM 2114.416D-V-AM
Fixture Consumption	12W / 22W / 34W / 44W
Voltage	120-277 VAC
Delivered Lumen	784 / 1568 (lm) 2352 / 3136 (lm)
Beam Angle	100°
CCT	3000K
CRI	90+
A: Driver Model	PUP10A-1WMC-350
B: Driver Model	PUP20A-1WMC
C: Driver Model	A+B Driver
D: Driver Model	B Driver X2

Bezel : Black White

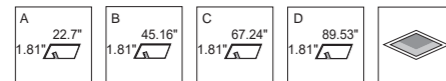
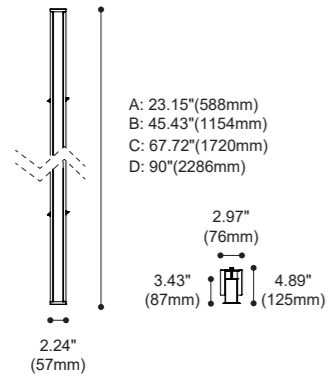

BROWNIE ONE 40-TLFP

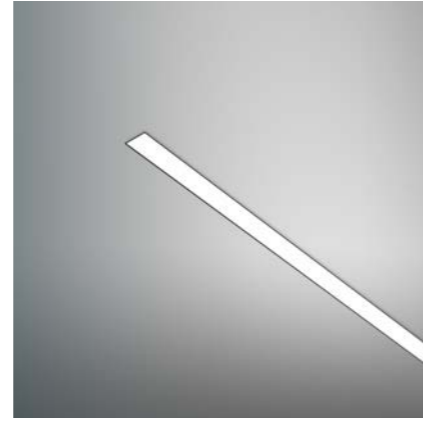

Article number	2114.516A-V-AM 2114.516B-V-AM 2114.516C-V-AM 2114.516D-V-AM
Fixture Consumption	12W / 22W / 34W / 44W
Voltage	120-277 VAC
Delivered Lumen	784 / 1568 (lm) 2352 / 3136 (lm)
Beam Angle	100°
CCT	3000K
CRI	90+
A: Driver Model	PUP10A-1WMC-350
B: Driver Model	PUP20A-1WMC
C: Driver Model	A+B Driver
D: Driver Model	B Driver X2

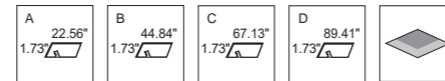
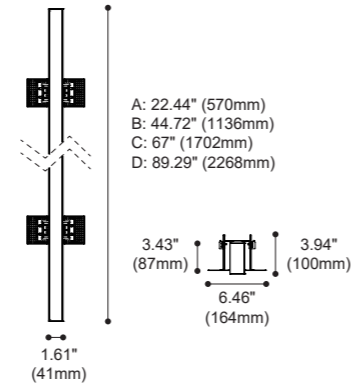

BROWNIE ONE 60-TFP

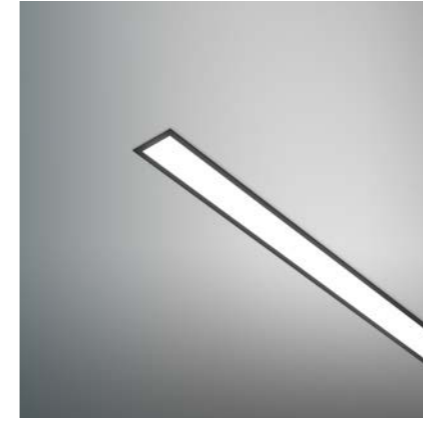

Article number	2114.417A-V-AM 2114.417B-V-AM 2114.417C-V-AM 2114.417D-V-AM
Fixture Consumption	18W / 34W / 52W / 68W
Voltage	120-277 VAC
Delivered Lumen	948 / 1896 (lm) 2844 / 3792 (lm)
Beam Angle	100°
CCT	3000K
CRI	90+
A: Driver Model	LX30W-55-C1050-RP
B: Driver Model	A Driver X2
C: Driver Model	A Driver X3
D: Driver Model	A Driver X4

Bezel : Black White

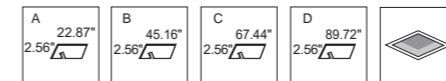
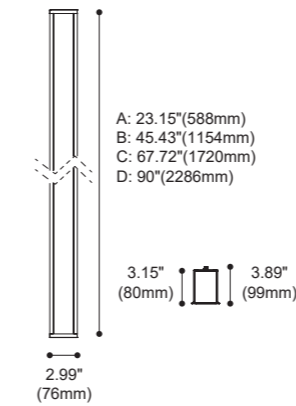

BROWNIE ONE 60-TLFP

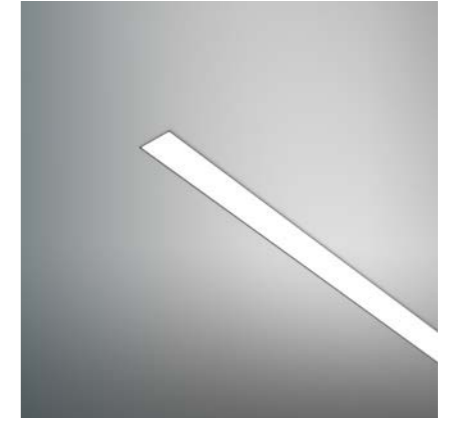

Article number	2114.517A-V-AM 2114.517B-V-AM 2114.517C-V-AM 2114.517D-V-AM
Fixture Consumption	18W / 34W / 52W / 68W
Voltage	120-277 VAC
Delivered Lumen	948 / 1896 (lm) 2844 / 3792 (lm)
Beam Angle	100°
CCT	3000K
CRI	90+
A: Driver Model	LX30W-55-C1050-RP
B: Driver Model	A Driver X2
C: Driver Model	A Driver X3
D: Driver Model	A Driver X4

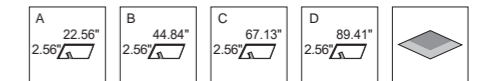
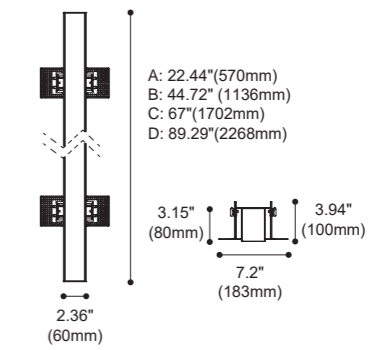



BROWNIE ONE **40/60** (AM)

Surface Mounted

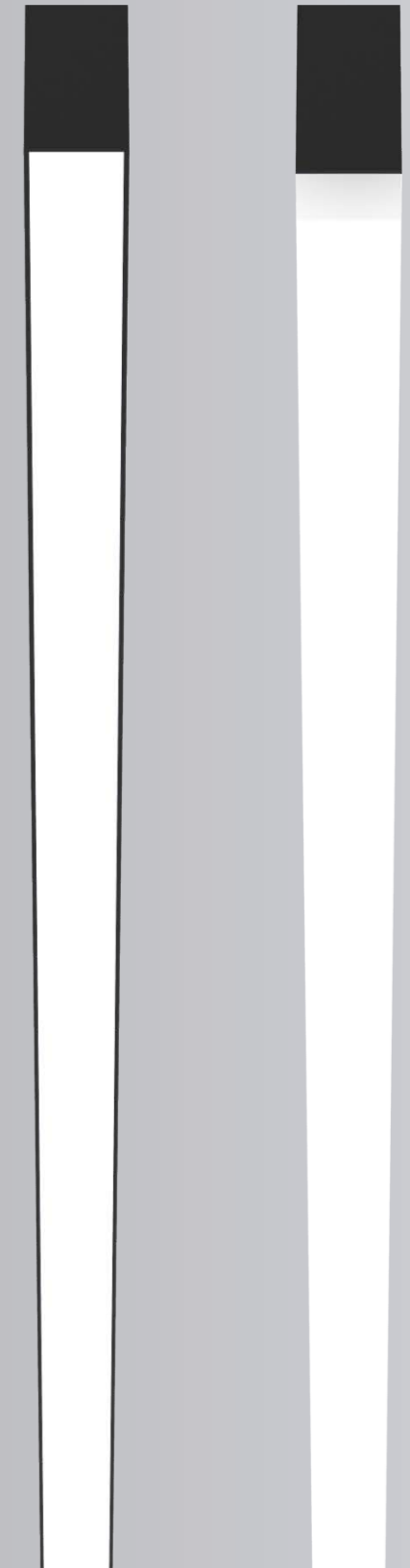

BROWNIE ONE 40-SF-1



Article number
2113.108A-V-AM
2113.108B-V-AM
2113.108C-V-AM
2113.108D-V-AM

Fixture Consumption 12W / 22W / 34W / 44W
Voltage 120-277 VAC
Delivered Lumen 784 / 1568 (lm)
2352 / 3136 (lm)
Beam Angle 100°
CCT 3000K
CRI 90+
A: Driver Model PUP10A-1WMC-350
B: Driver Model PUP20A-1WMC
C: Driver Model A+B Driver
D: Driver Model B Driver X2

Bezel : Black White

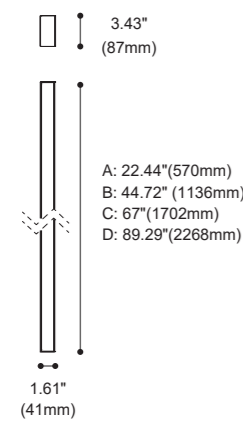

BROWNIE ONE 40-SF-2



Article number
2113.109A-V-AM
2113.109B-V-AM
2113.109C-V-AM
2113.109D-V-AM

Fixture Consumption 12W / 22W / 34W / 44W
Voltage 120-277 VAC
Delivered Lumen 784 / 1568 (lm)
2352 / 3136 (lm)
Beam Angle 110°
CCT 3000K
CRI 90+
A: Driver Model PUP10A-1WMC-350
B: Driver Model PUP20A-1WMC
C: Driver Model A+B Driver
D: Driver Model B Driver X2

Bezel : Black White

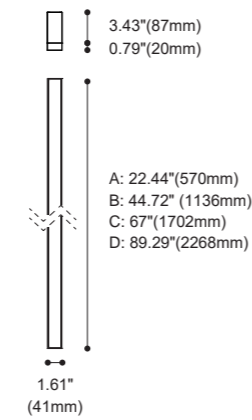

BROWNIE ONE 60-SF-1

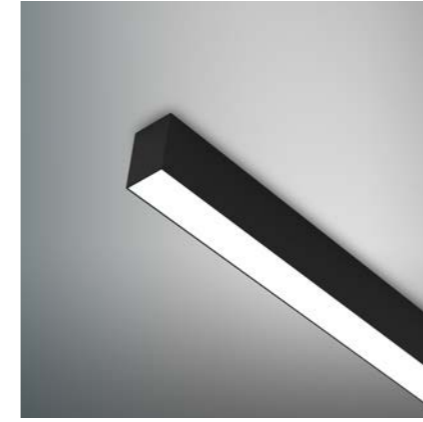

Article number
2113.110A-V-AM
2113.110B-V-AM
2113.110C-V-AM
2113.110D-V-AM

Fixture Consumption 18W / 34W / 52W / 68W
Voltage 120-277 VAC
Delivered Lumen 948 / 1896 (lm)
2844 / 3792 (lm)
Beam Angle 100°
CCT 3000K
CRI 90+
A: Driver Model LX30W-55-C1050-RP
B: Driver Model A Driver X2
C: Driver Model A Driver X3
D: Driver Model A Driver X4

Bezel : Black White

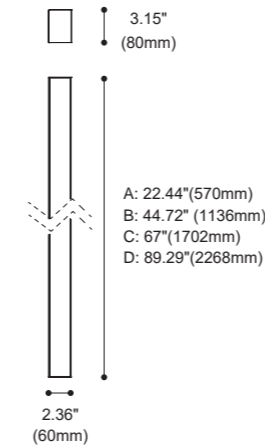

BROWNIE ONE 60-SF-2



Article number
2113.111A-V-AM
2113.111B-V-AM
2113.111C-V-AM
2113.111D-V-AM

Fixture Consumption 18W / 34W / 52W / 68W
Voltage 120-277 VAC
Delivered Lumen 948 / 1896 (lm)
2844 / 3792 (lm)
Beam Angle 110°
CCT 3000K
CRI 90+
A: Driver Model LX30W-55-C1050-RP
B: Driver Model A Driver X2
C: Driver Model A Driver X3
D: Driver Model A Driver X4

Bezel : Black White

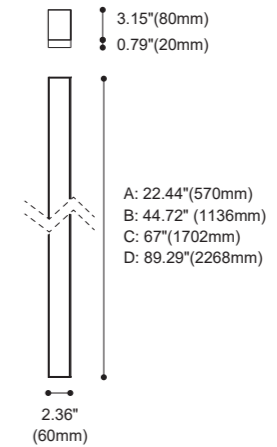
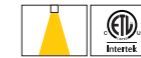



BROWNIE ONE **40/60** (AM)

Pendant

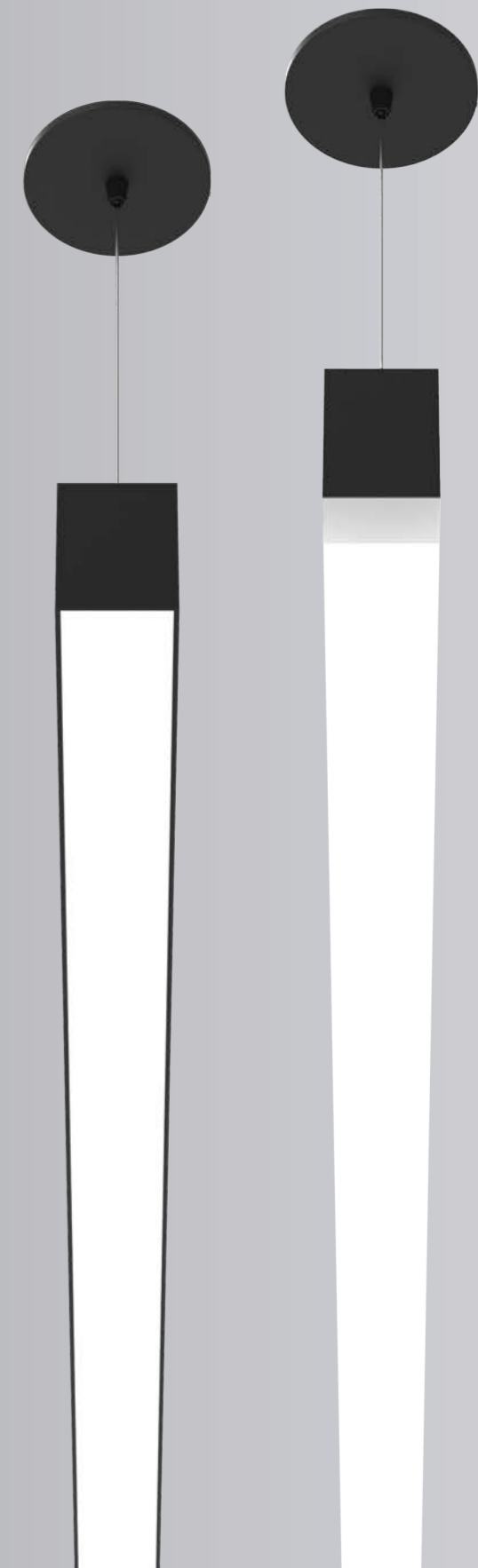

BROWNIE ONE 40-P-1

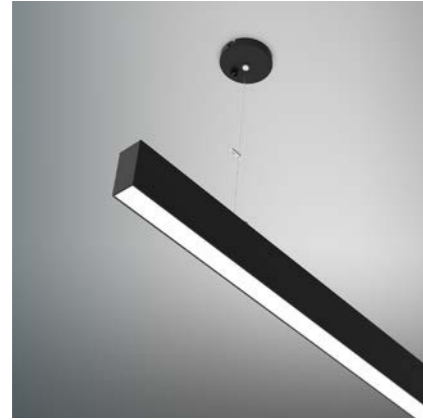

Article number	2116.110A-V-AM 2116.110B-V-AM 2116.110C-V-AM 2116.110D-V-AM
Fixture Consumption	12W / 22W / 34W / 44W
Voltage	120-277 VAC
Delivered Lumen	784 / 1568 (lm) 2352 / 3136 (lm)
Beam Angle	100°
CCT	3000K
CRI	90+
A: Driver Model	PUP10A-1WMC-350
B: Driver Model	PUP20A-1WMC
C: Driver Model	A+B Driver
D: Driver Model	B Driver X2

Bezel : Black White

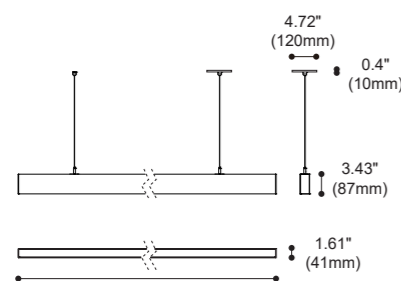

A: 22.44"(570mm)
B: 44.72" (1136mm)
C: 67"(1702mm)
D: 89.29"(2268mm)

BROWNIE ONE 40-P-2

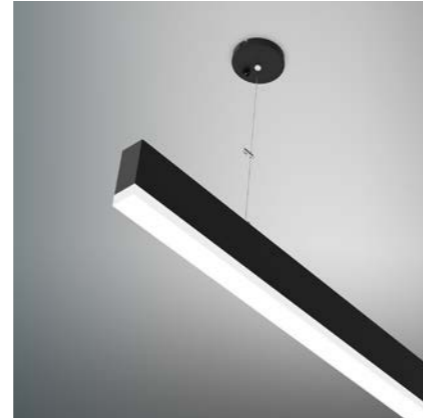

Article number	2116.111A-V-AM 2116.111B-V-AM 2116.111C-V-AM 2116.111D-V-AM
Fixture Consumption	12W / 22W / 34W / 44W
Voltage	120-277 VAC
Delivered Lumen	784 / 1568 (lm) 2352 / 3136 (lm)
Beam Angle	110°
CCT	3000K
CRI	90+
A: Driver Model	PUP10A-1WMC-350
B: Driver Model	PUP20A-1WMC
C: Driver Model	A+B Driver
D: Driver Model	B Driver X2

Bezel : Black White

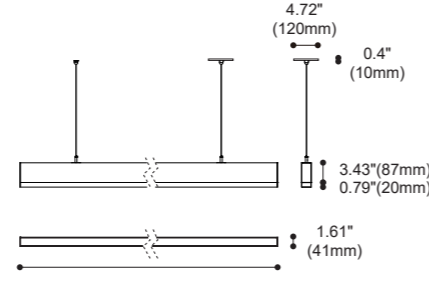

A: 22.44"(570mm)
B: 44.72" (1136mm)
C: 67"(1702mm)
D: 89.29"(2268mm)

BROWNIE ONE 60-P-1

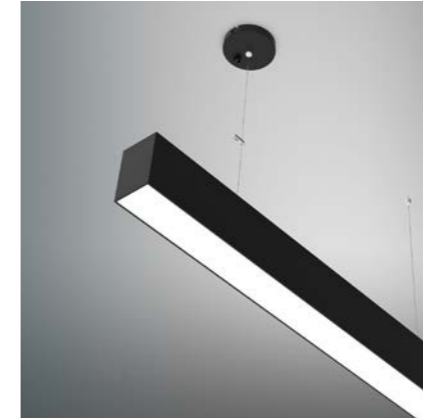

Article number	2116.112A-V-AM 2116.112B-V-AM 2116.112C-V-AM 2116.112D-V-AM
Fixture Consumption	18W / 34W / 52W / 68W
Voltage	120-277 VAC
Delivered Lumen	948 / 1896 (lm) 2844 / 3792 (lm)
Beam Angle	100°
CCT	3000K
CRI	90+
A: Driver Model	LX30W-55-C1050-RP
B: Driver Model	A Driver X2
C: Driver Model	A Driver X3
D: Driver Model	A Driver X4

Bezel : Black White

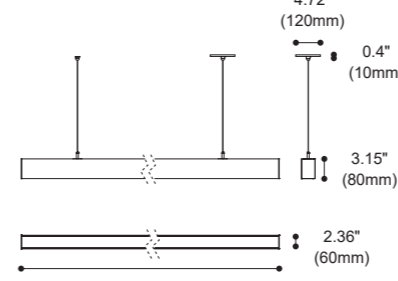

A: 22.44"(570mm)
B: 44.72" (1136mm)
C: 67"(1702mm)
D: 89.29"(2268mm)

BROWNIE ONE 60-P-2



Article number	2116.113A-V-AM 2116.113B-V-AM 2116.113C-V-AM 2116.113D-V-AM
Fixture Consumption	18W / 34W / 52W / 68W
Voltage	120-277 VAC
Delivered Lumen	948 / 1896 (lm) 2844 / 3792 (lm)
Beam Angle	110°
CCT	3000K
CRI	90+
A: Driver Model	LX30W-55-C1050-RP
B: Driver Model	A Driver X2
C: Driver Model	A Driver X3
D: Driver Model	A Driver X4

Bezel : Black White

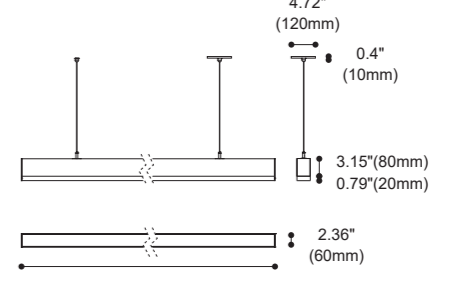

A: 22.44"(570mm)
B: 44.72" (1136mm)
C: 67"(1702mm)
D: 89.29"(2268mm)